



CHEVROLET

**1975**

# CHEVROLET

**TRUCK  
WIRING  
DIAGRAMS**

**SUPPLEMENT**

CHEVROLET MOTOR DIVISION  
General Motors Corporation  
DETROIT, MICHIGAN

ST 352 - 75

## INTRODUCTION

This booklet contains Wiring Diagrams for 1975 truck models listed in the index below.

Refer to 1974 Truck Wiring Diagram book for all 1975 model trucks **NOT** covered in this booklet (those built prior to March 1, 1975). For models built after March 1, 1975, refer to 1975 Truck Wiring Diagrams book covering series 40-45 and up which will be available March 1, 1975.

## INDEX

TRUCK SERIES	CAB, ENGINE, & CHASSIS DIAGRAM	FOOTNOTES
C-10,20,30; C-15,25,35	A-3409	(1)
K-10,20,30; K-15,25,35	A-3409	(1)
P-10,20,30; P-15,25,35	A-3411	(2) (3)
G-10,20,30; G-15,25,35	A-3414	(4)
C-80; D-80	A-3415	

## FOOTNOTES

FOOTNOTE NO.	DIAGRAM TITLE	DIAGRAM NO.
1	MISCELLANEOUS R.P.O. EQUIPMENT	A-3410
2	P-30; P-35 MOTOR HOME CHASSIS	A-3412
3	P-10,20,30; P-15,25,35 - FORWARD CONTROL CHASSIS	A-3413
4	MISCELLANEOUS R.P.O. EQUIPMENT	A-3416

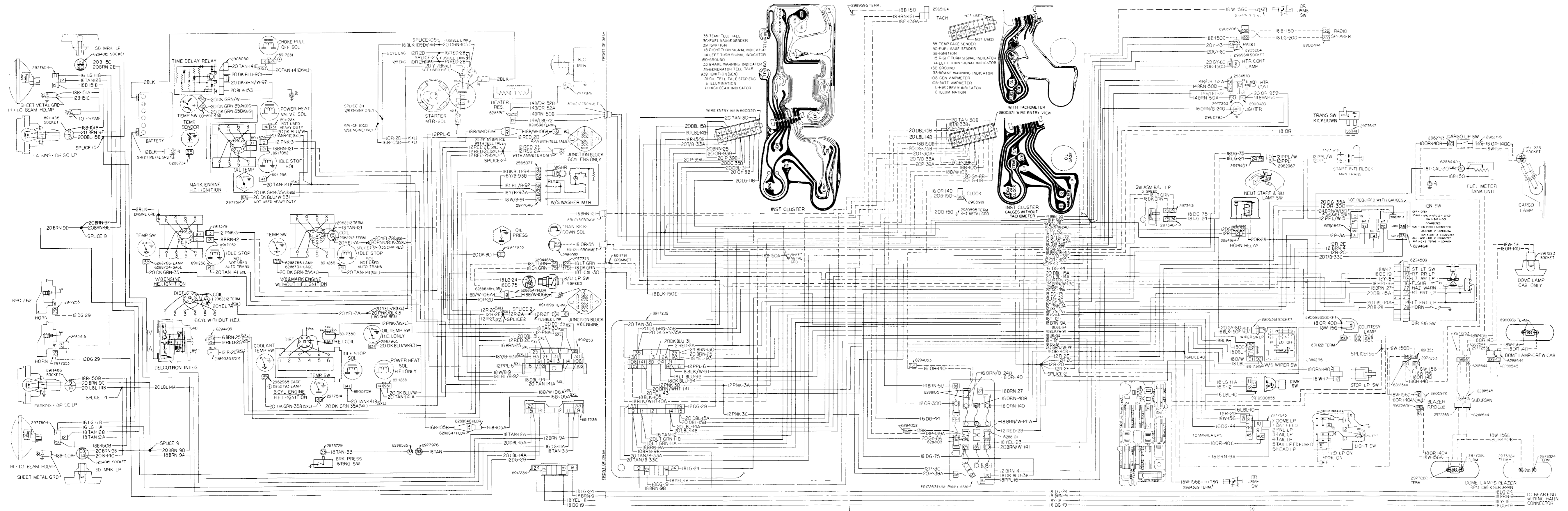

Left Side—Cab, Engine and Chassis Wiring—C/K-10,20,30; C/K-15,25,35—A-3409

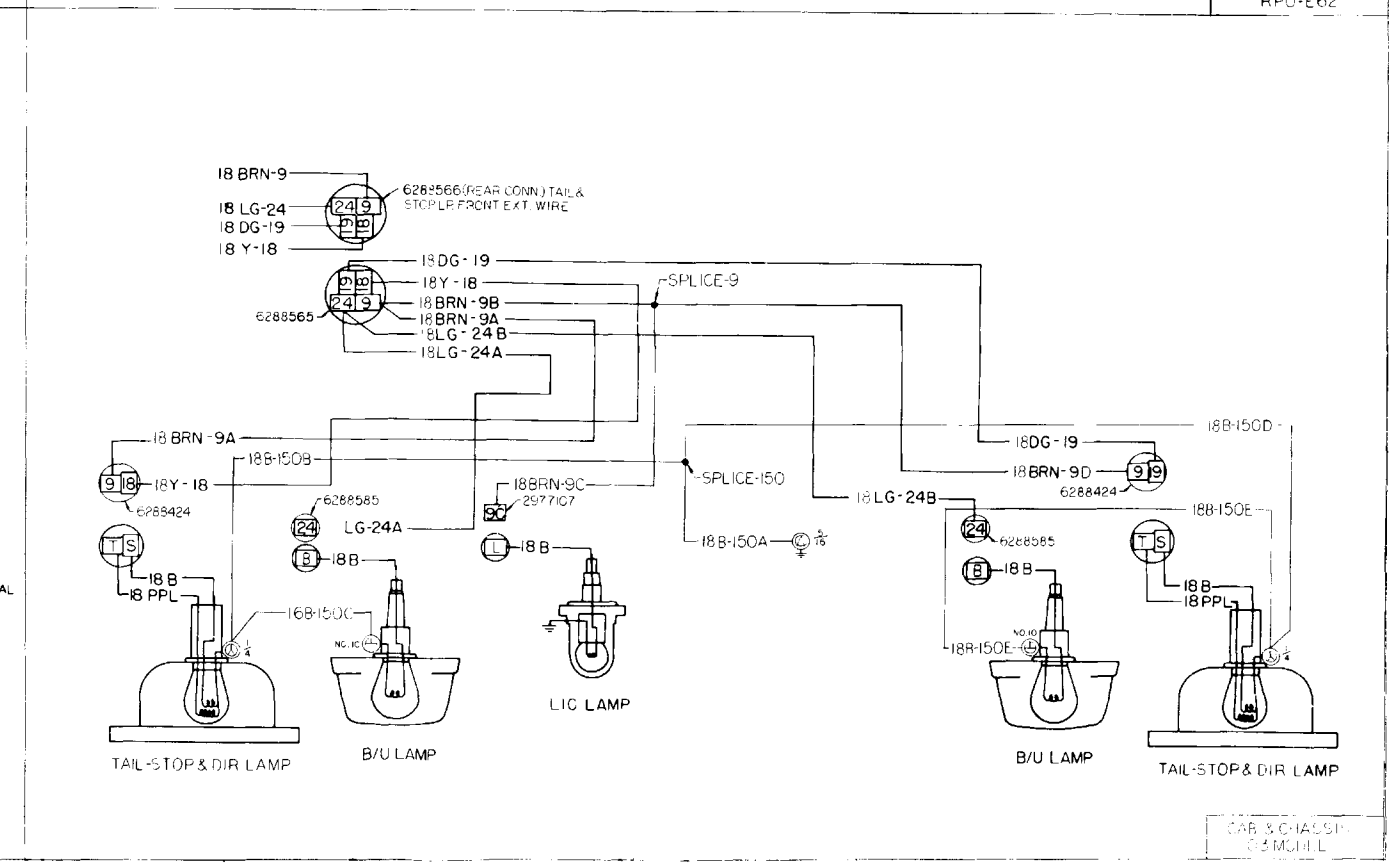
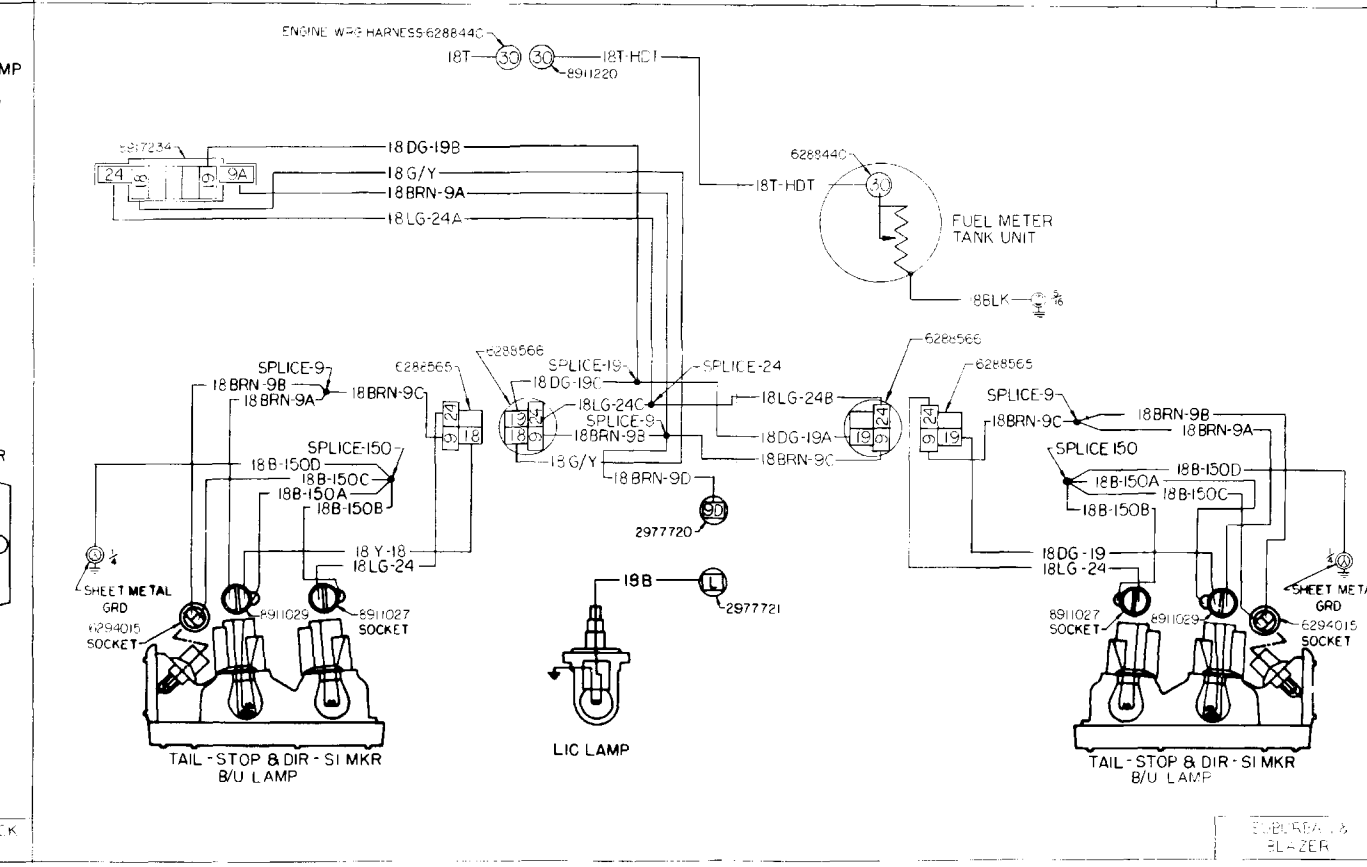
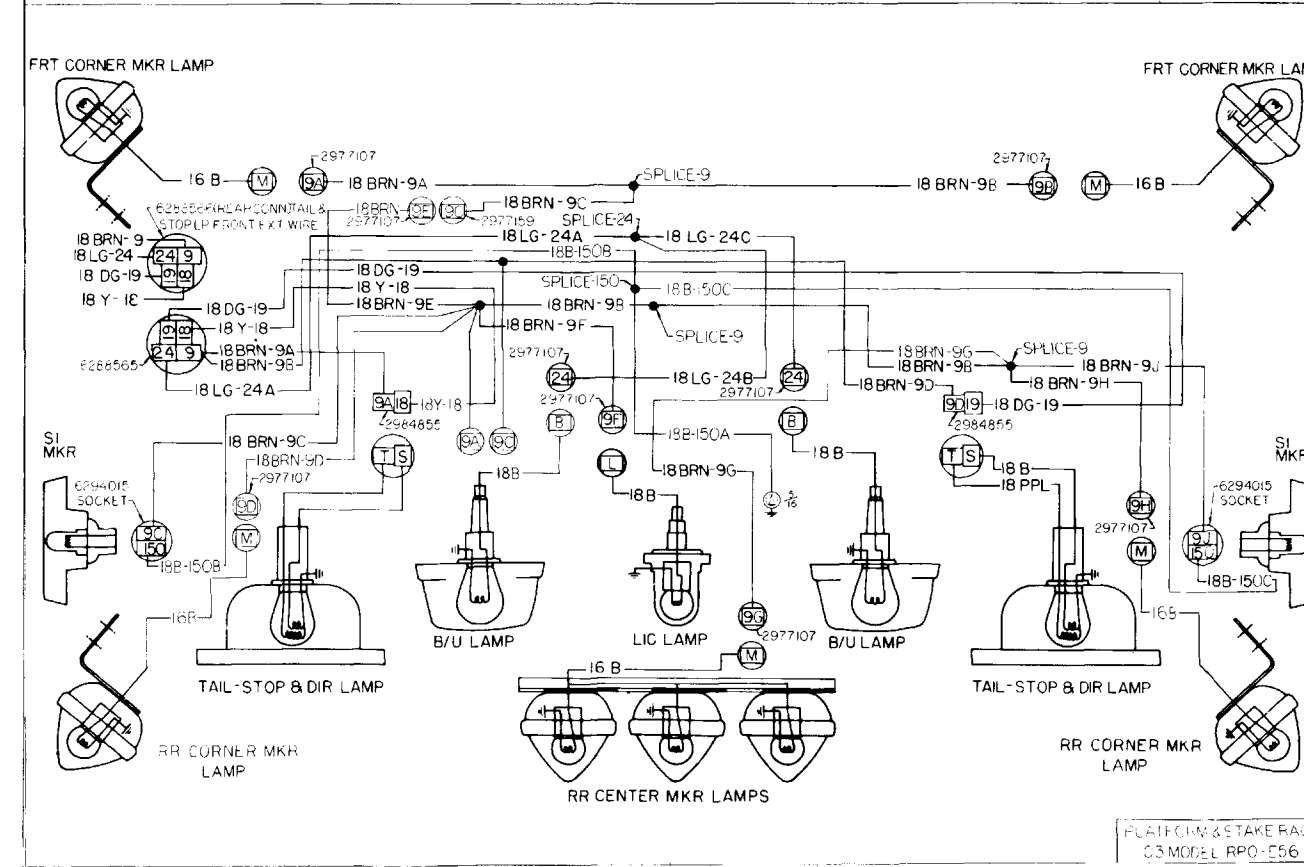
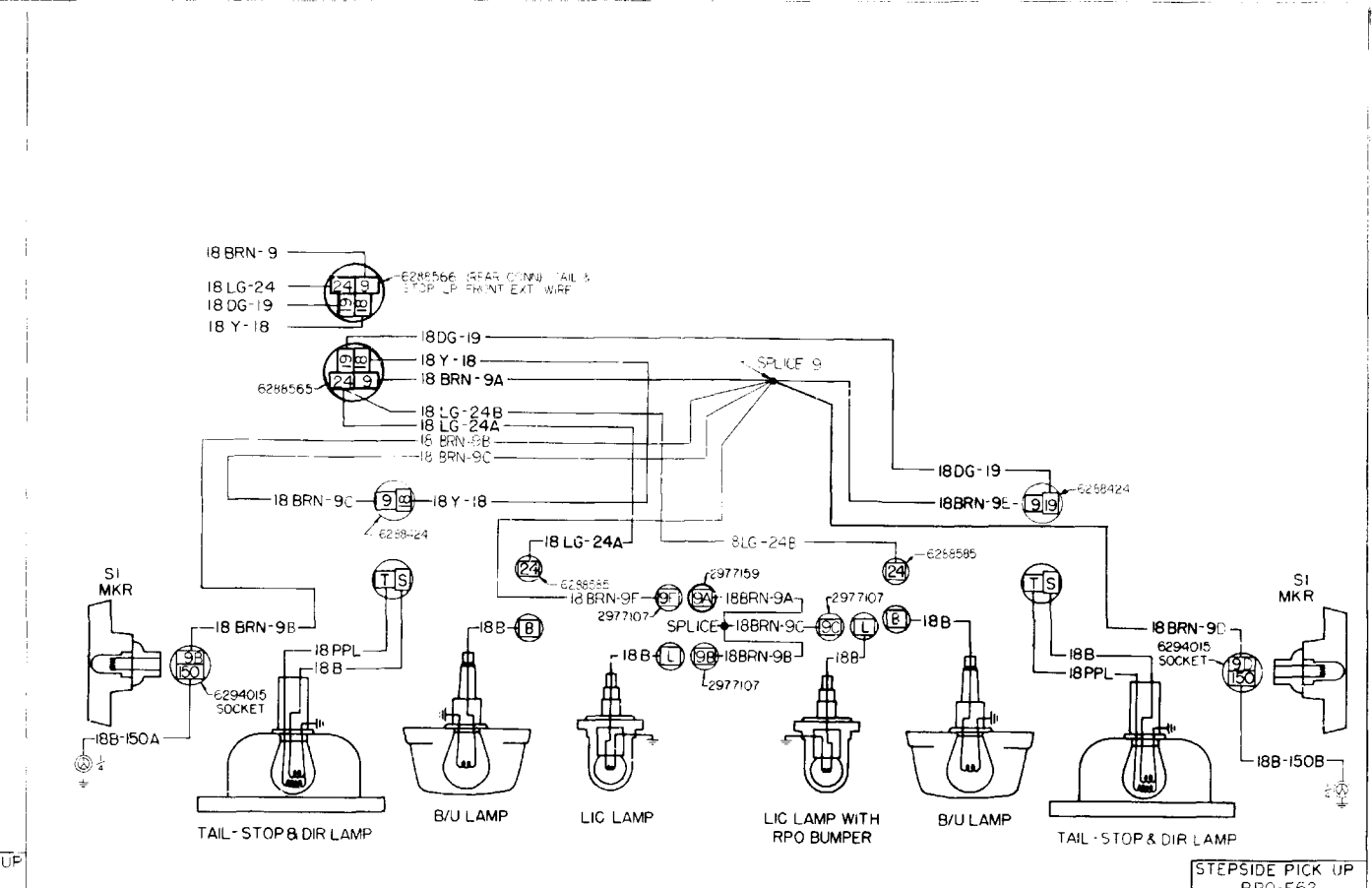
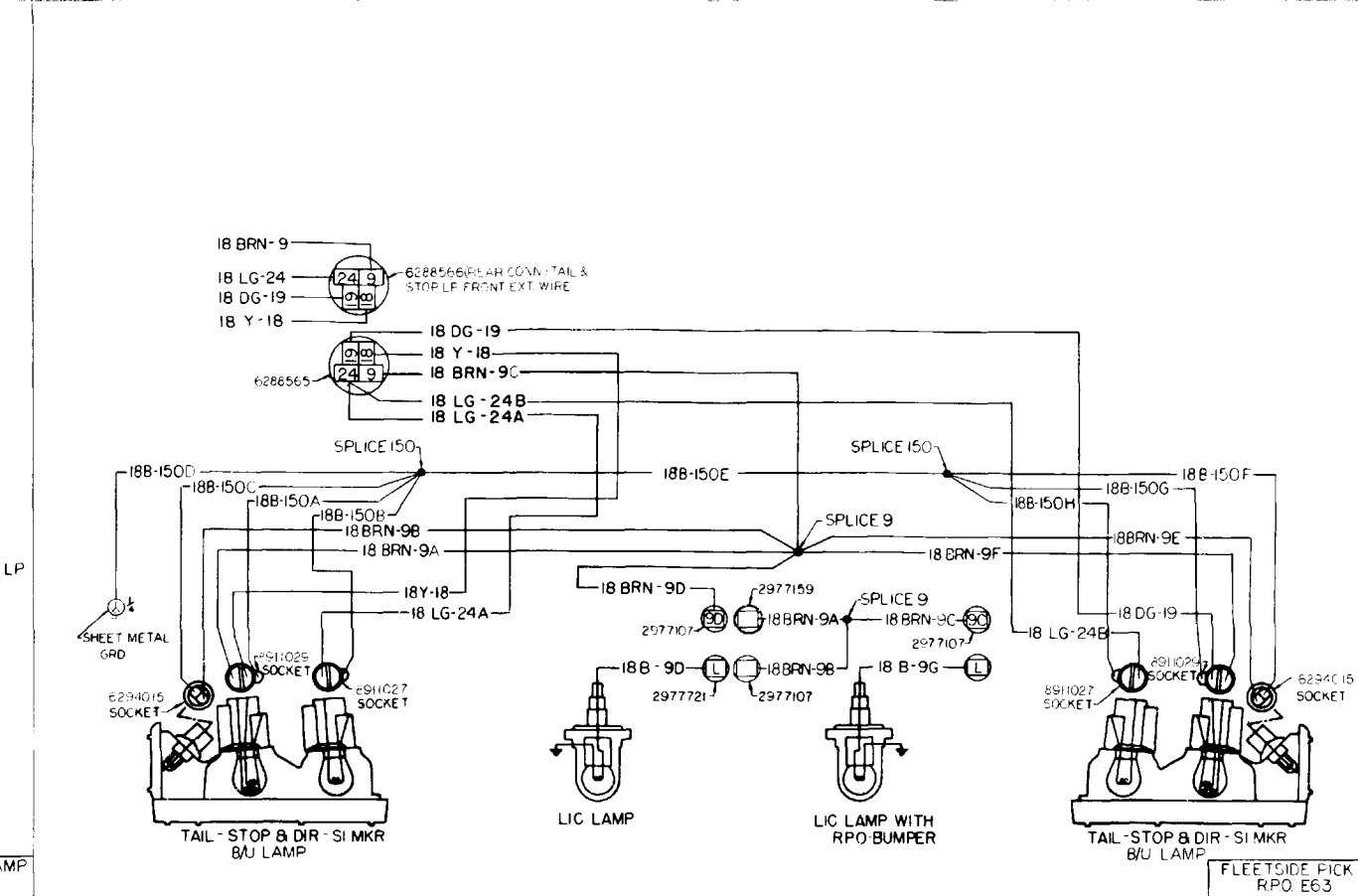
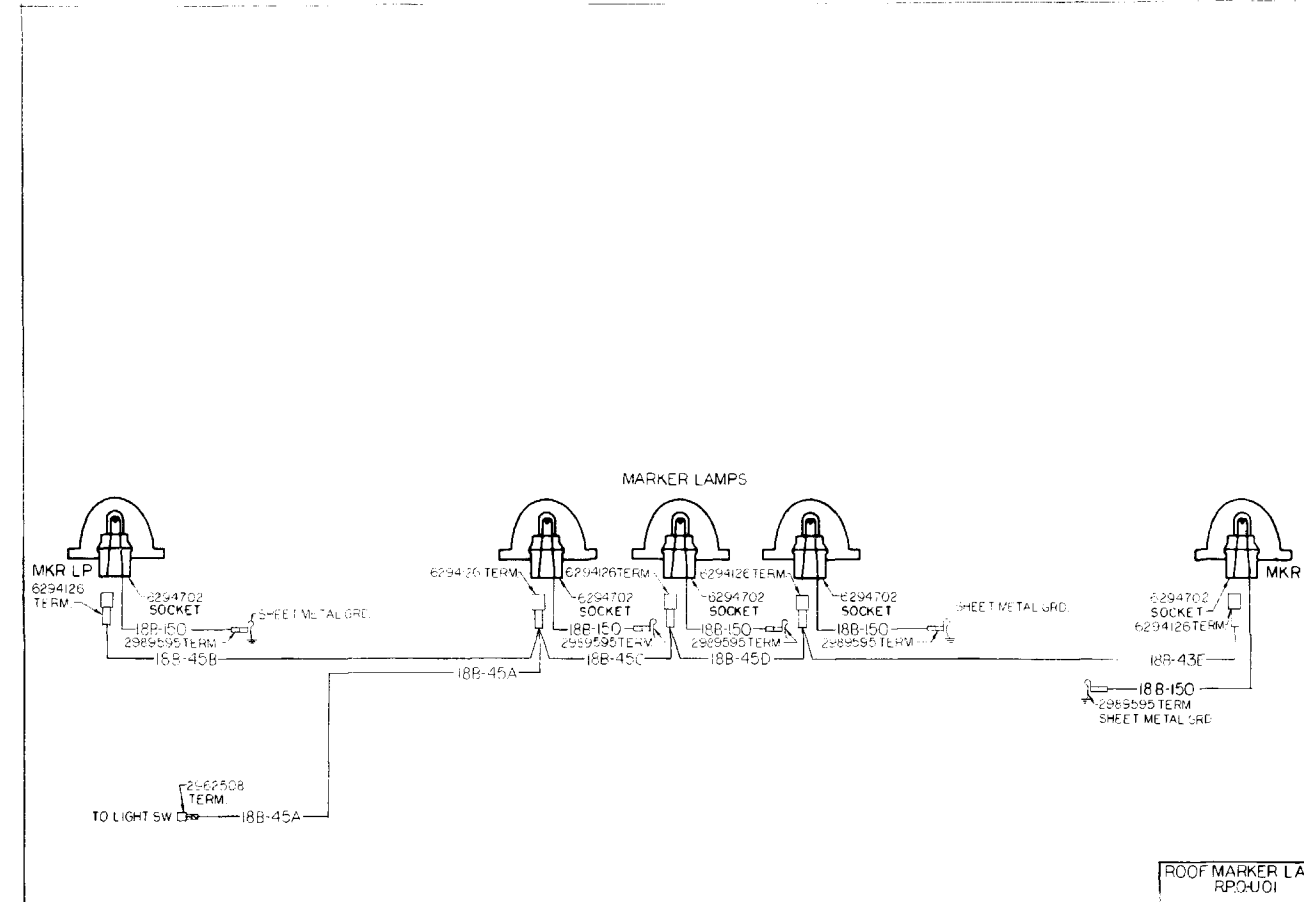



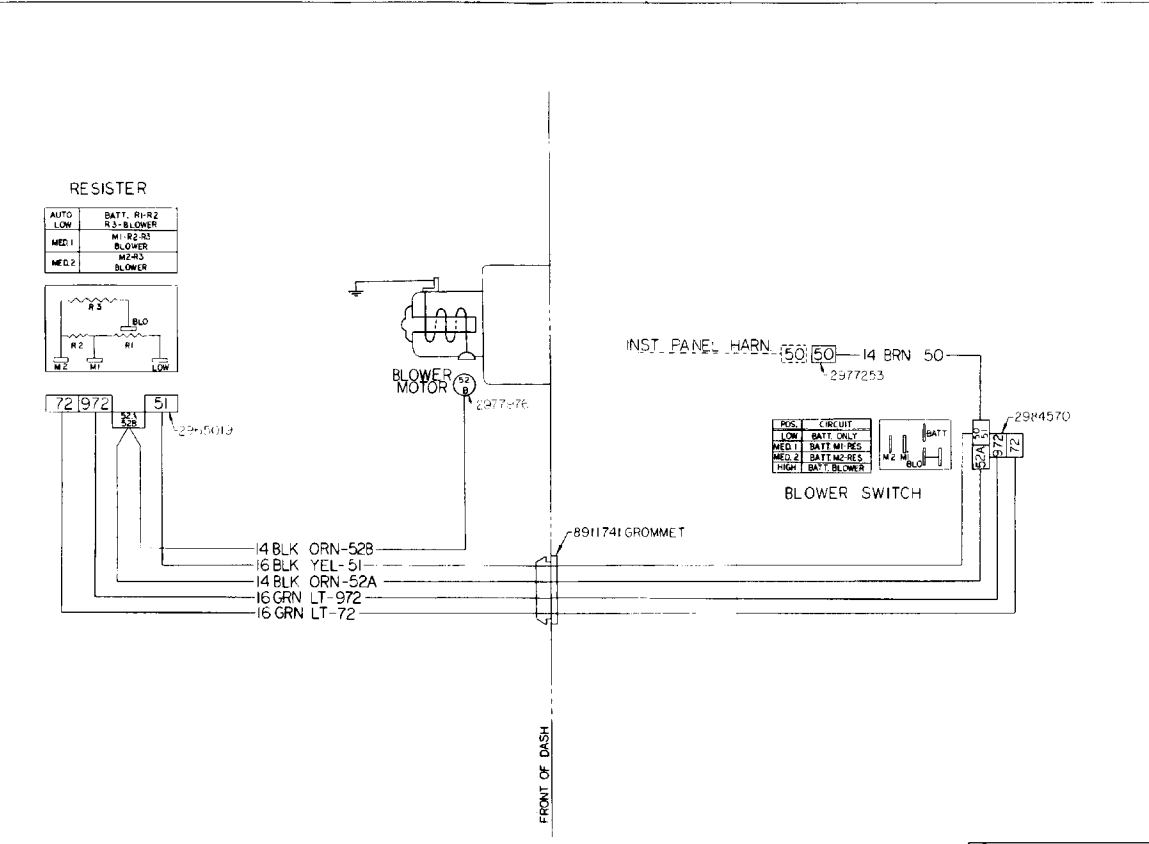

HEATER-HEAVY DUTY RPO C42

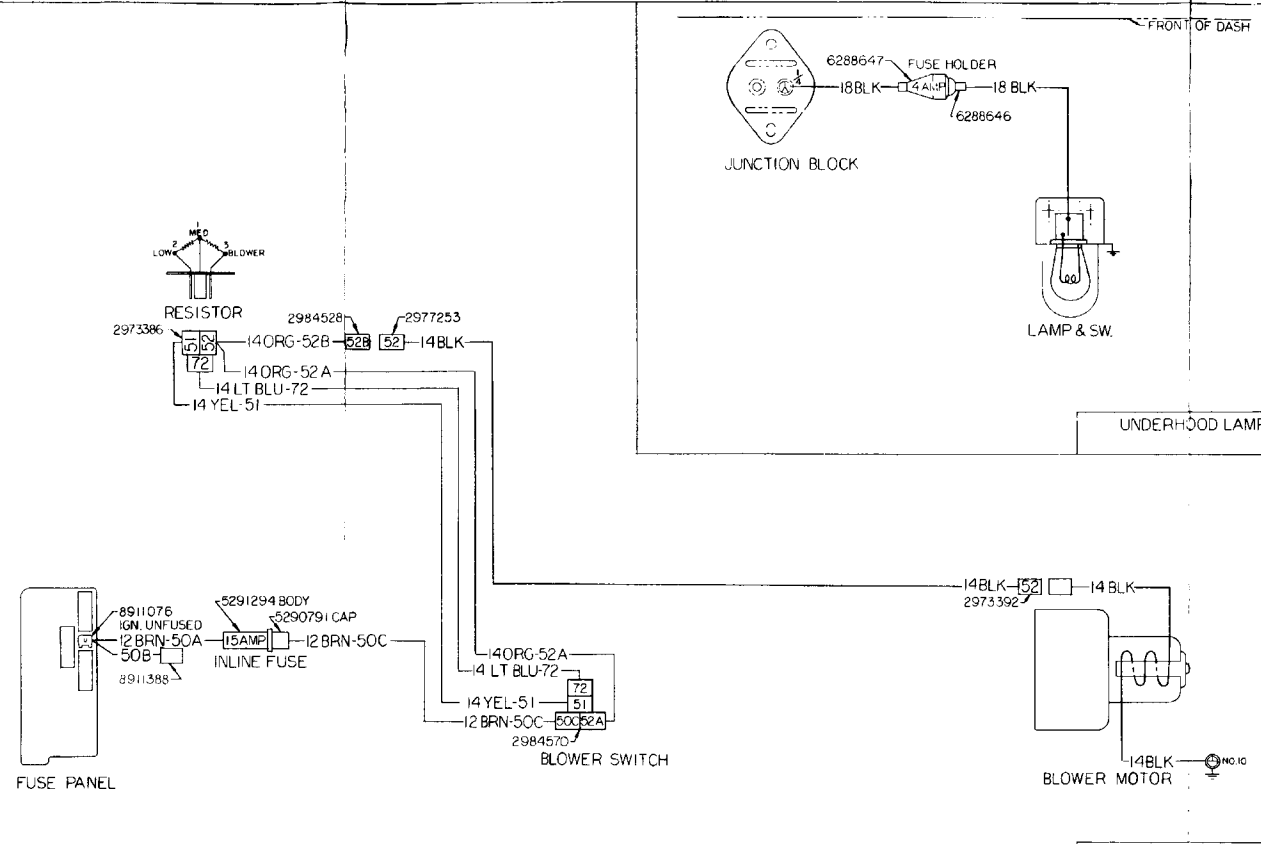

AUXILIARY HEATER

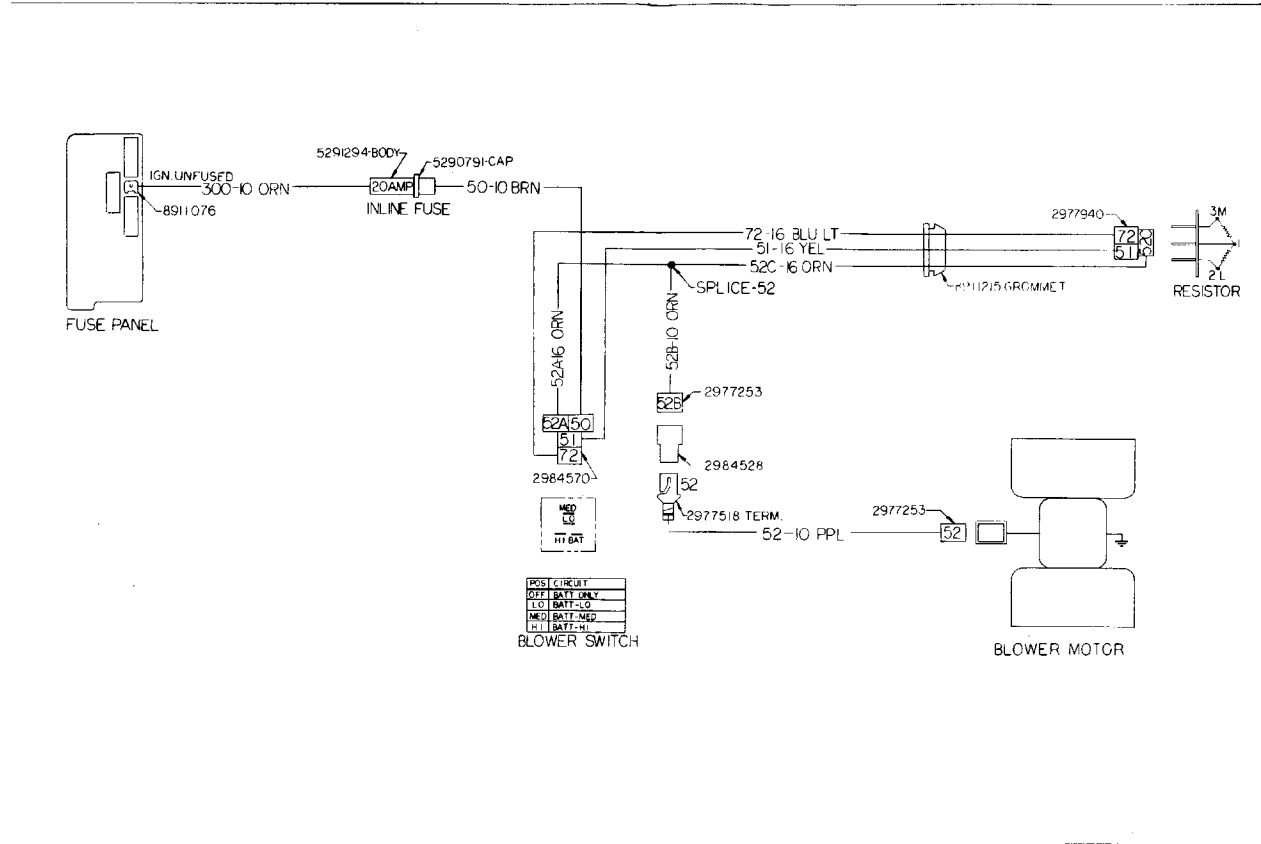

AIR CONDITIONING RPO C69

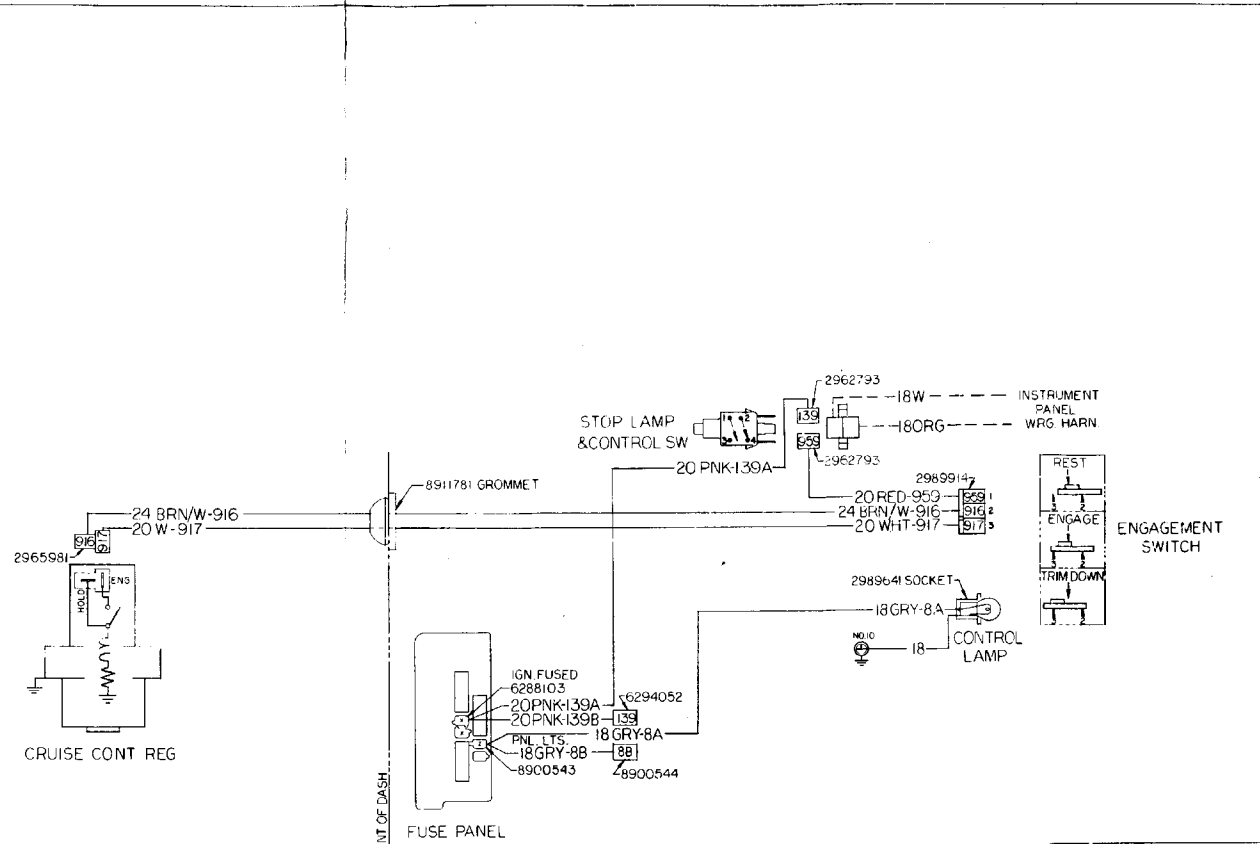

CRUISE CONTROL EQUIPMENT

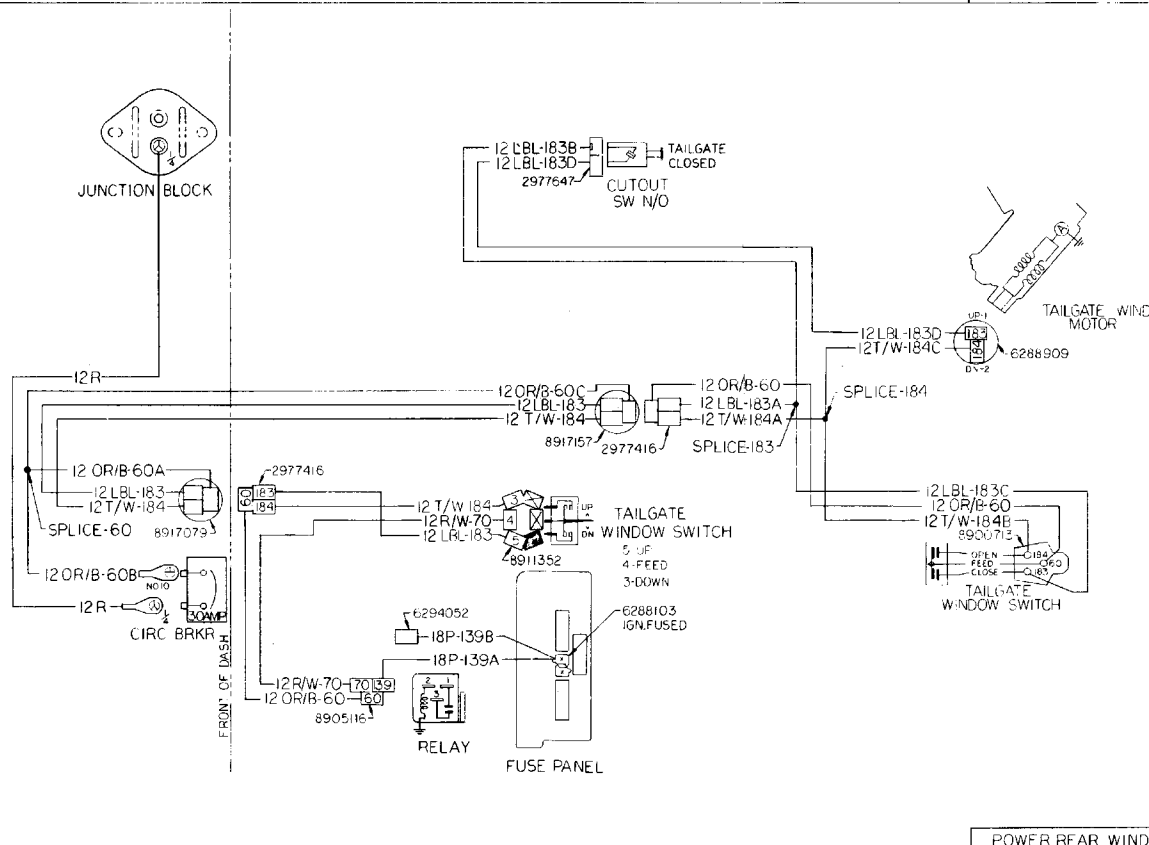

POWER REAR WINDOW SUBURBAN RPO A33

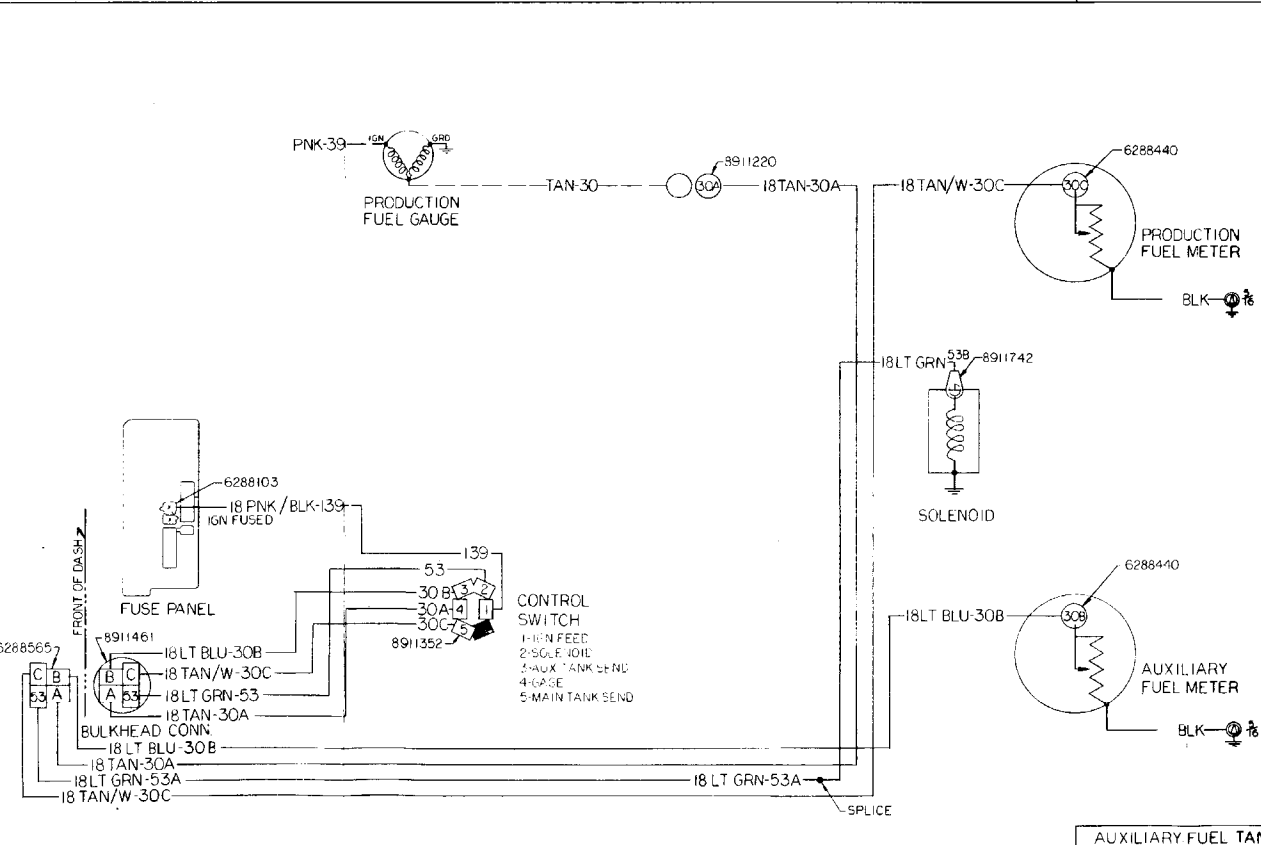

AUXILIARY FUEL TANK RPO N2

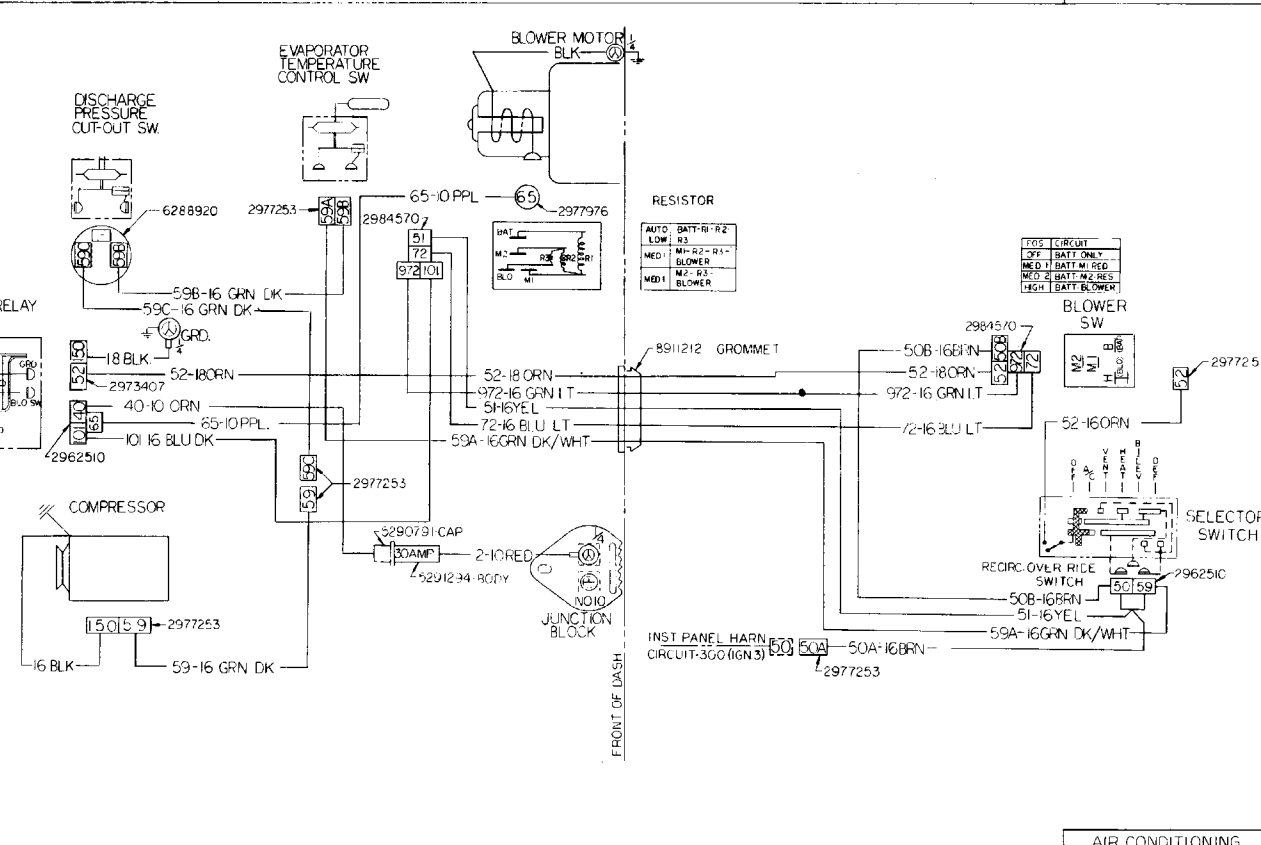

AIR CONDITIONING RPO C60

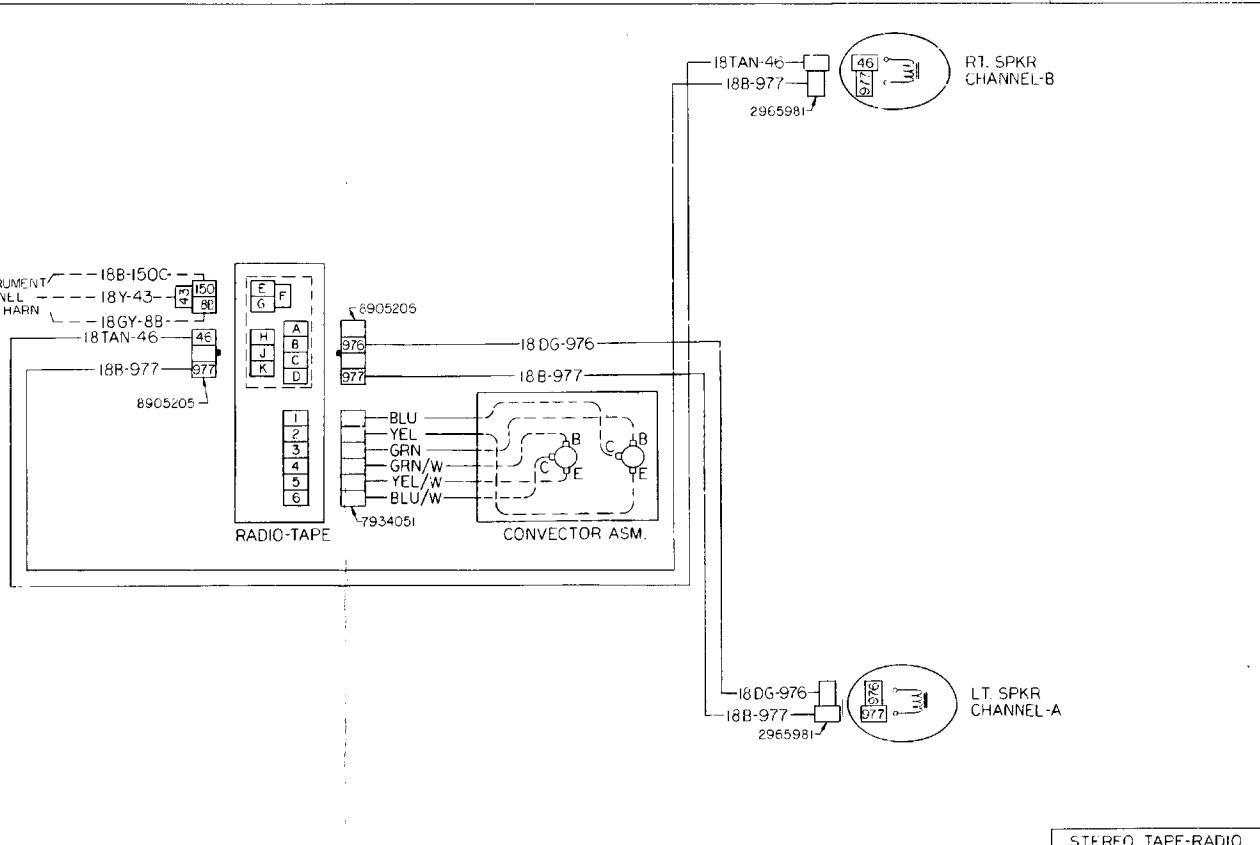

STEREO TAPE-RADIO EQUIPMENT

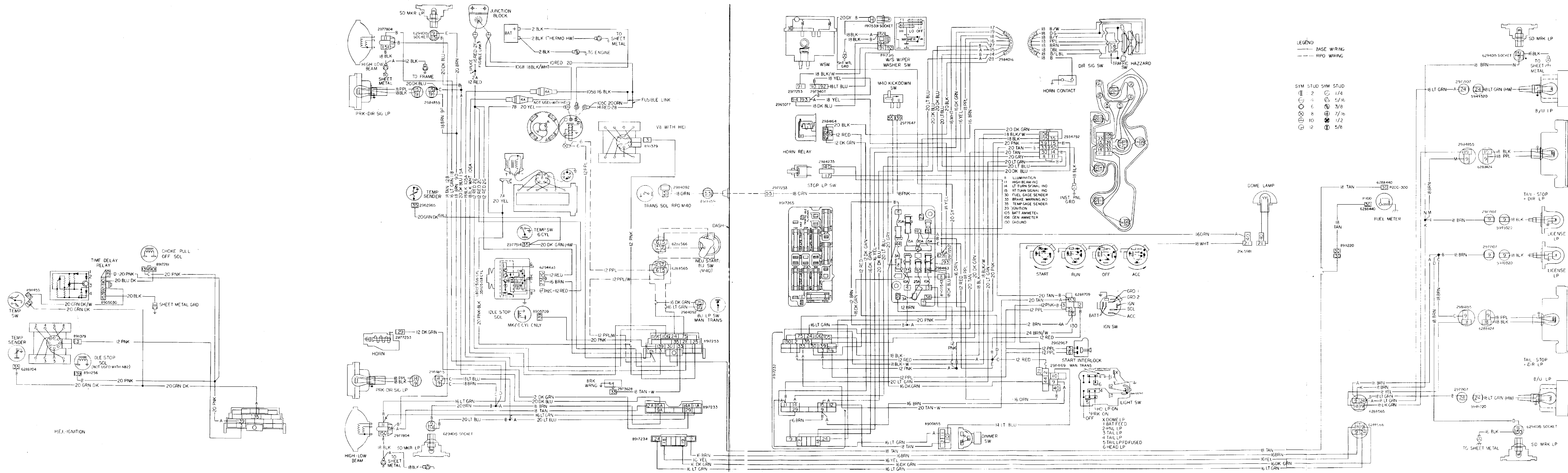

Cab, Engine and Chassis Wiring—P-10,20,30; P-15,25,35—A-3411

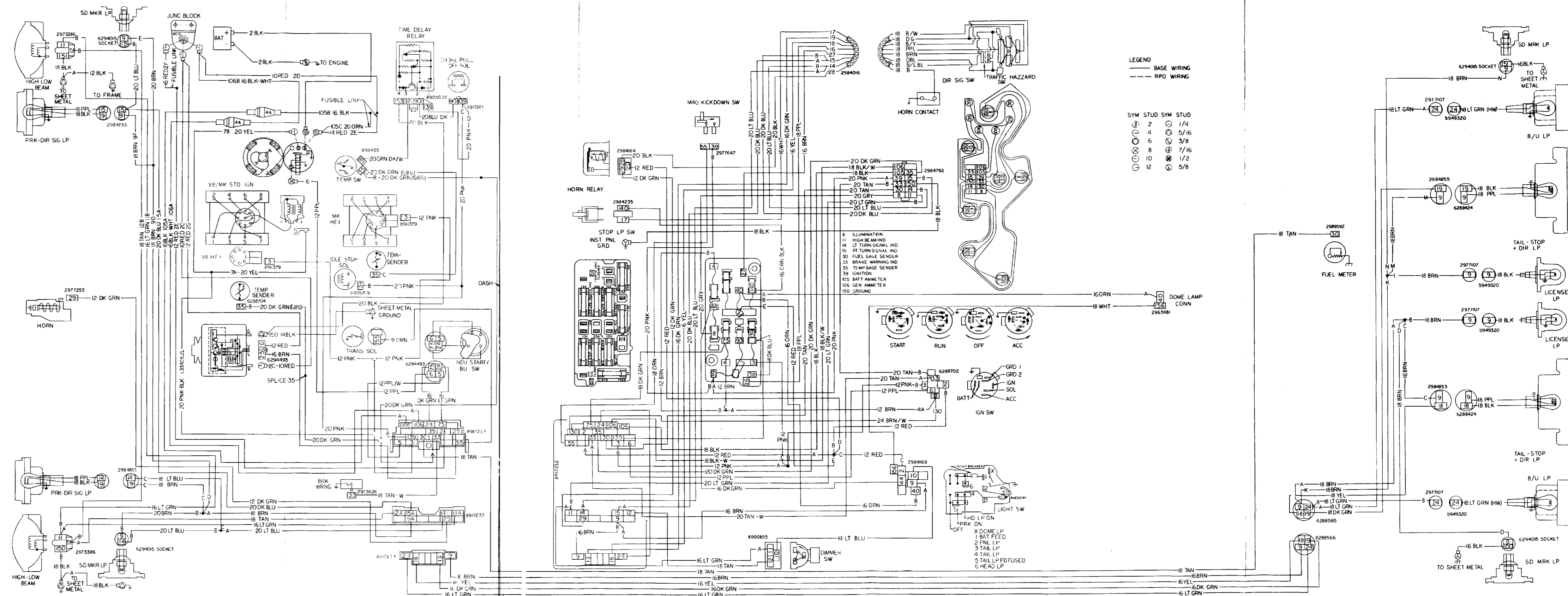



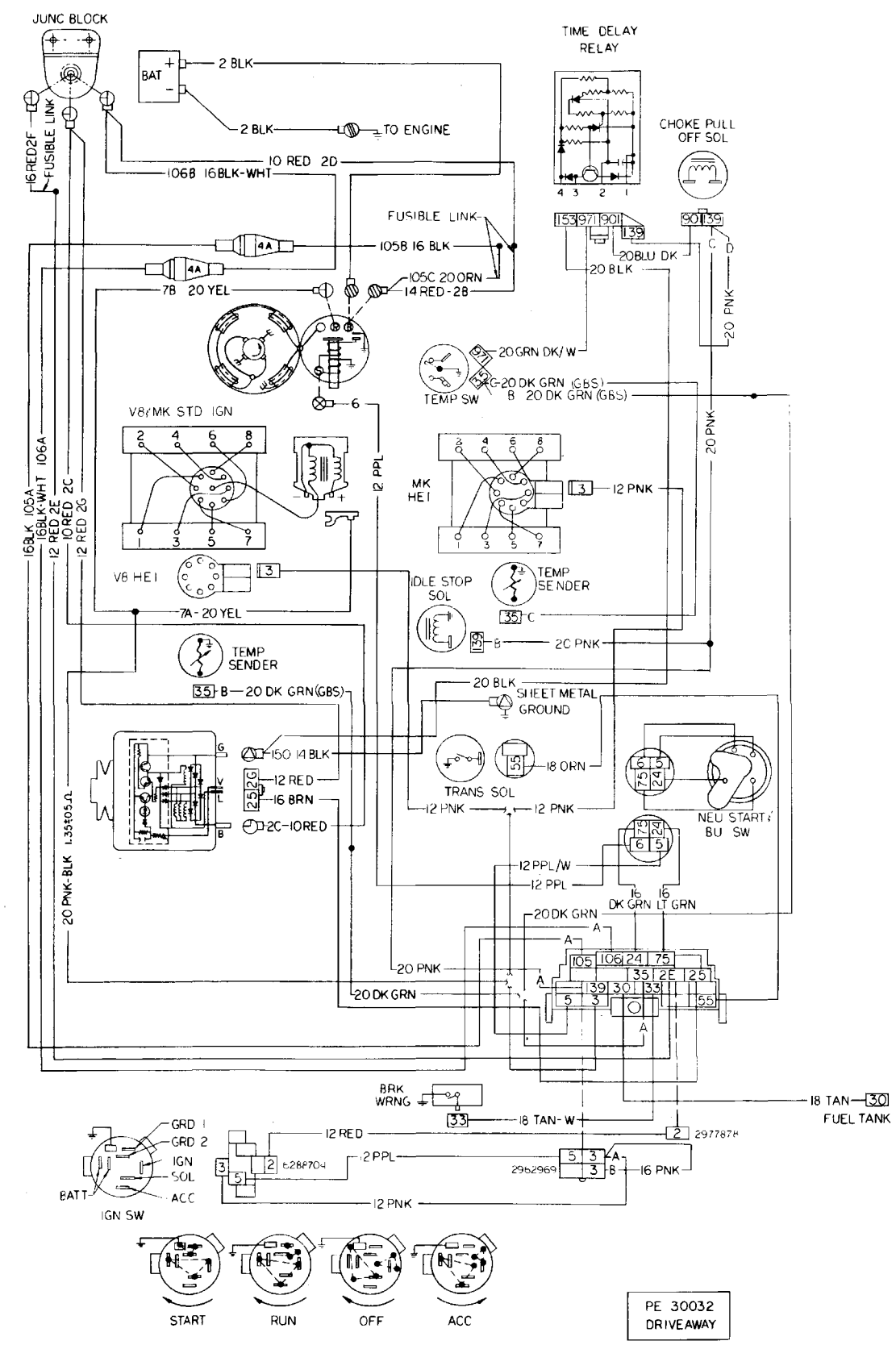

LEGEND

— BASE WIRING  
 - - - RPO WIRING

SYM	STUD	SYM	STUD
⊕	2	⊕	1/4
⊕	4	⊕	5/16
⊕	6	⊕	3/8
⊕	8	⊕	7/16
⊕	10	⊕	1/2
⊕	12	⊕	5/8

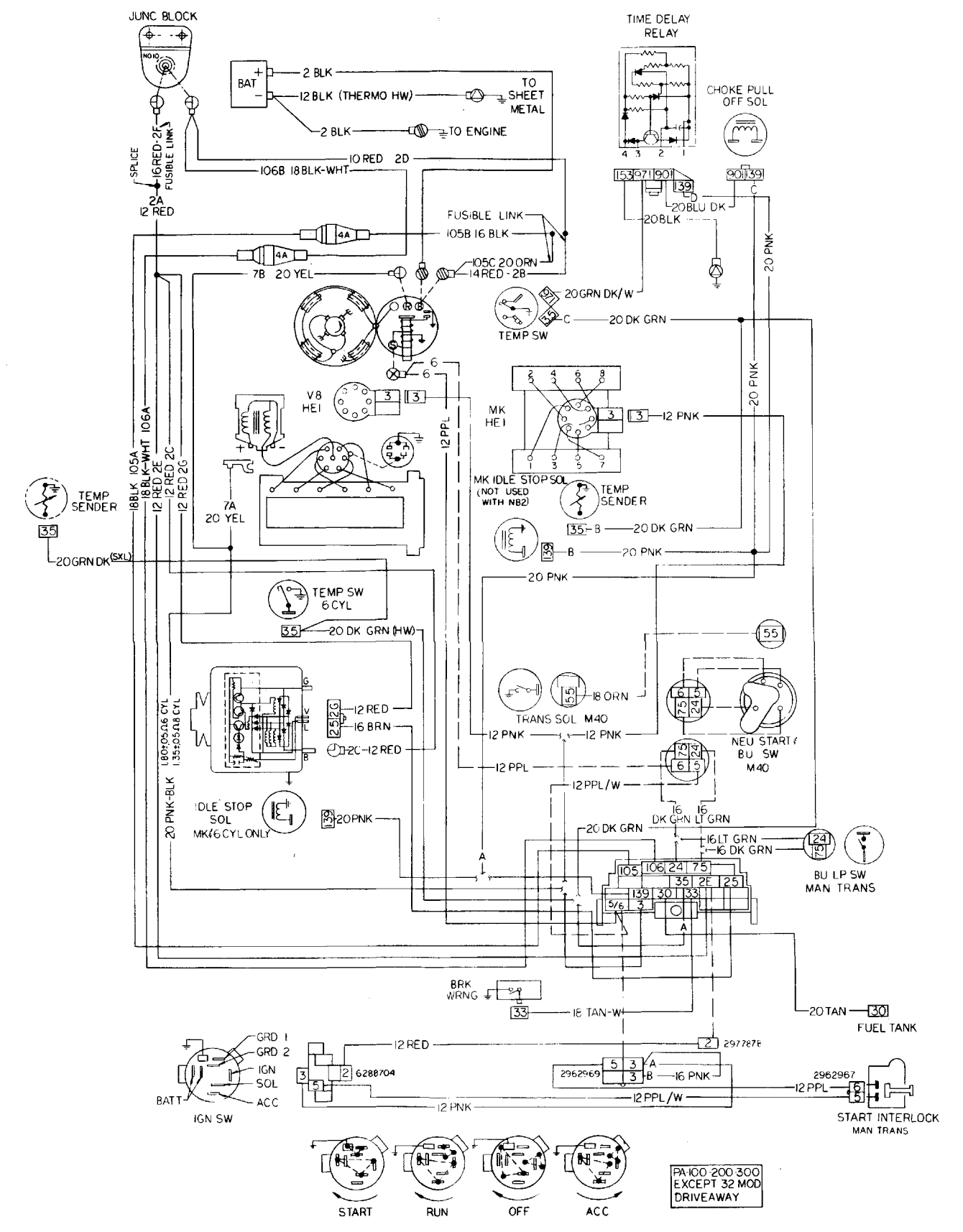

Forward Control Chassis Wiring—P-10,20,30; P-15,25,35—A-3413

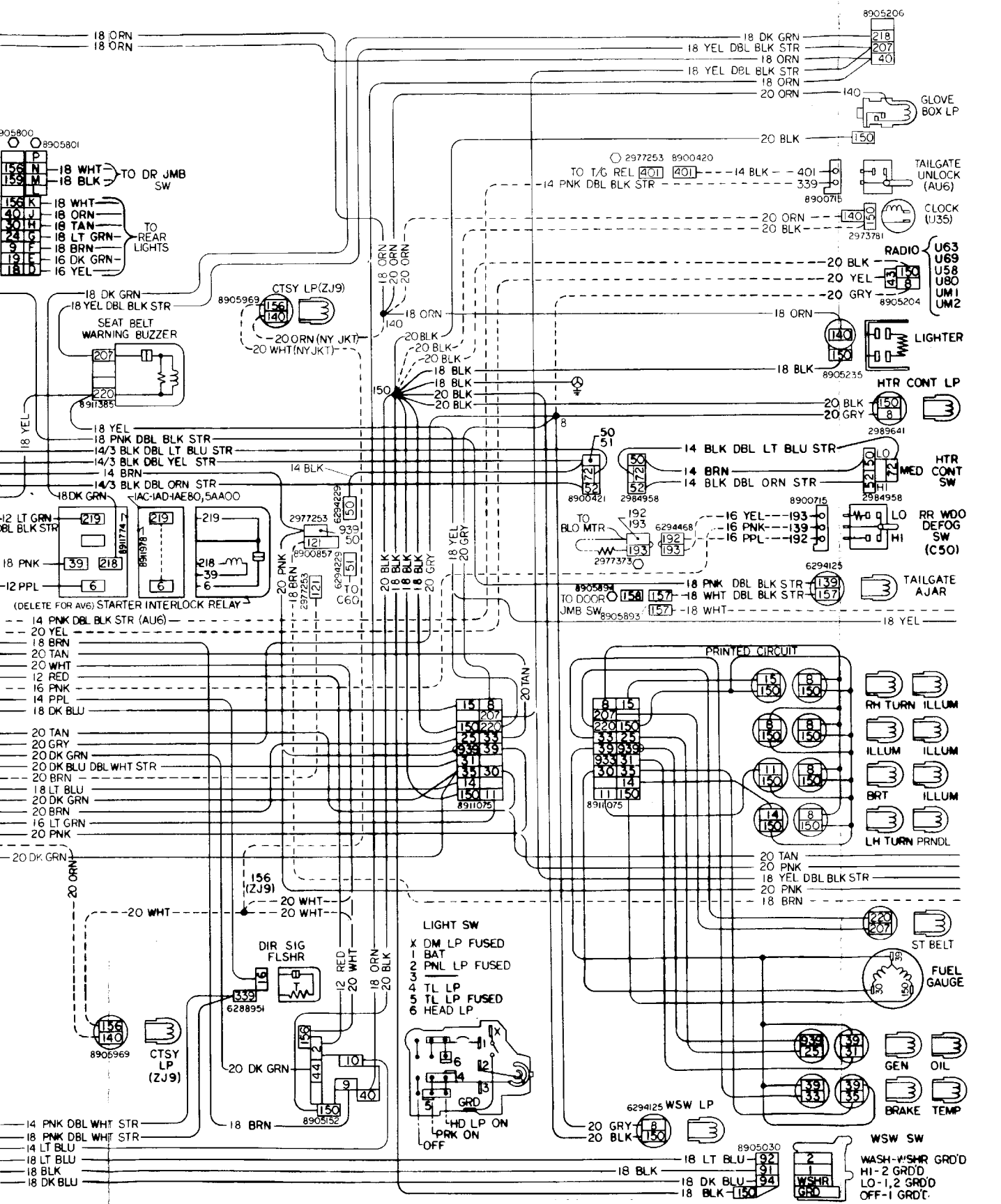
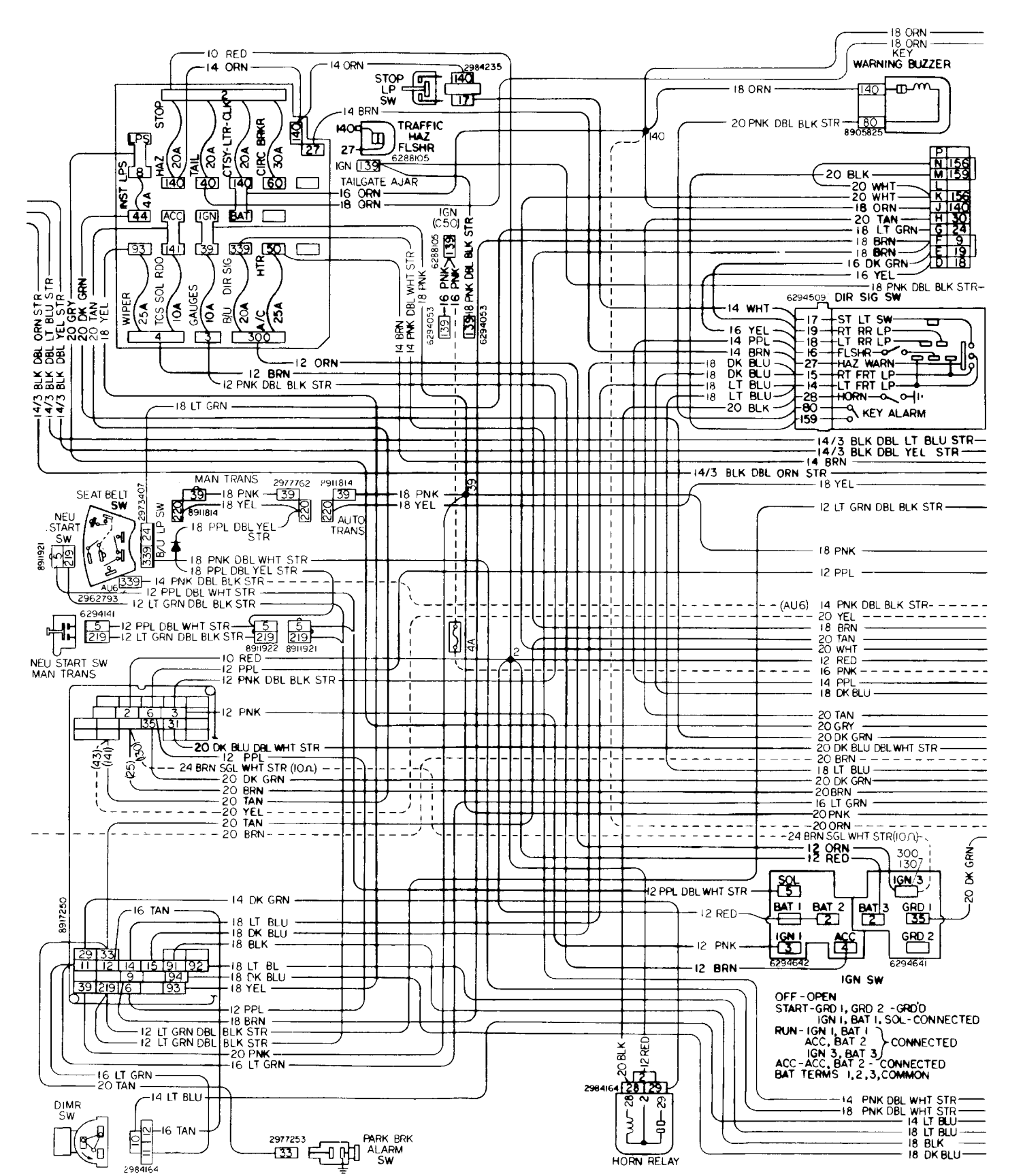
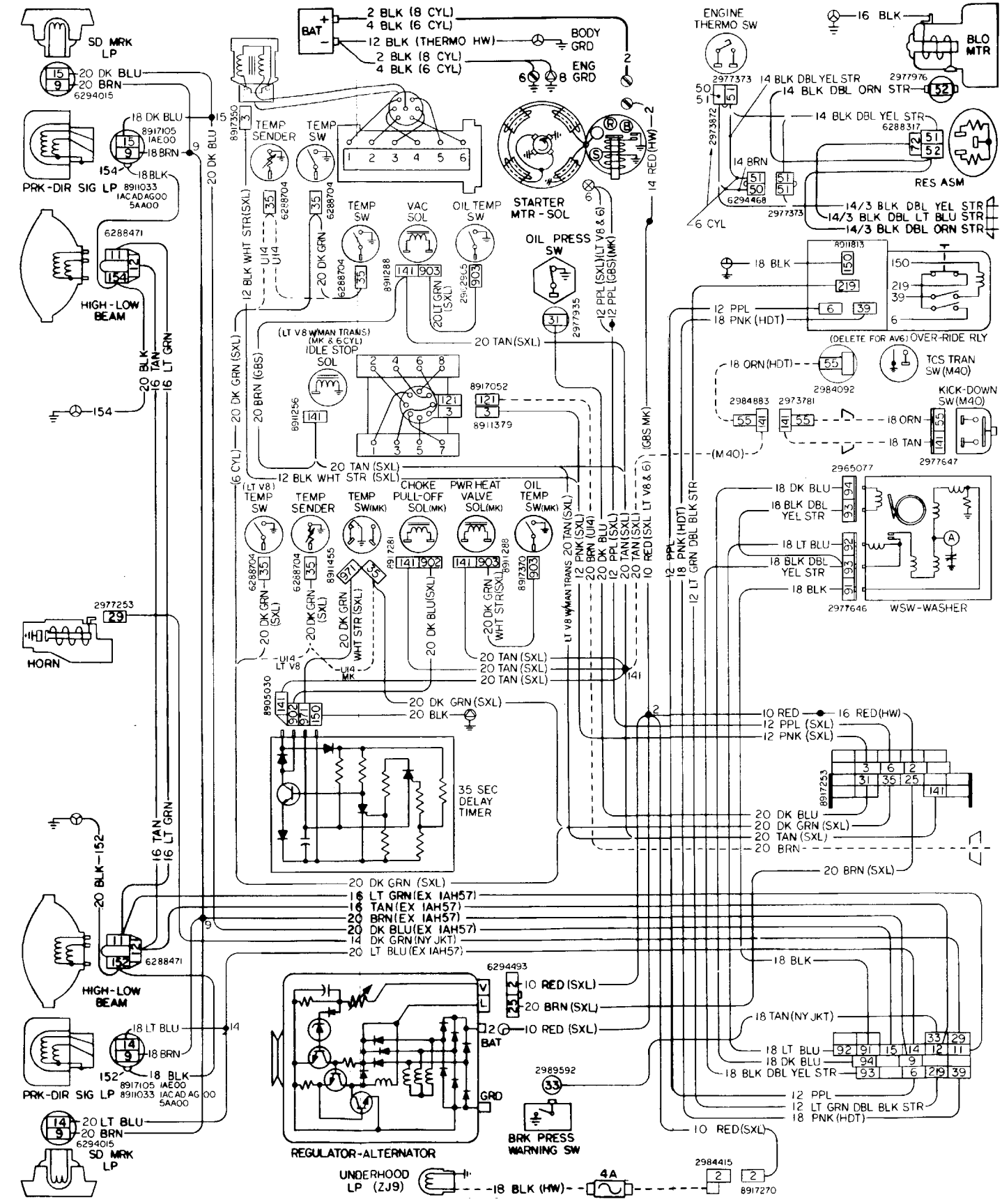
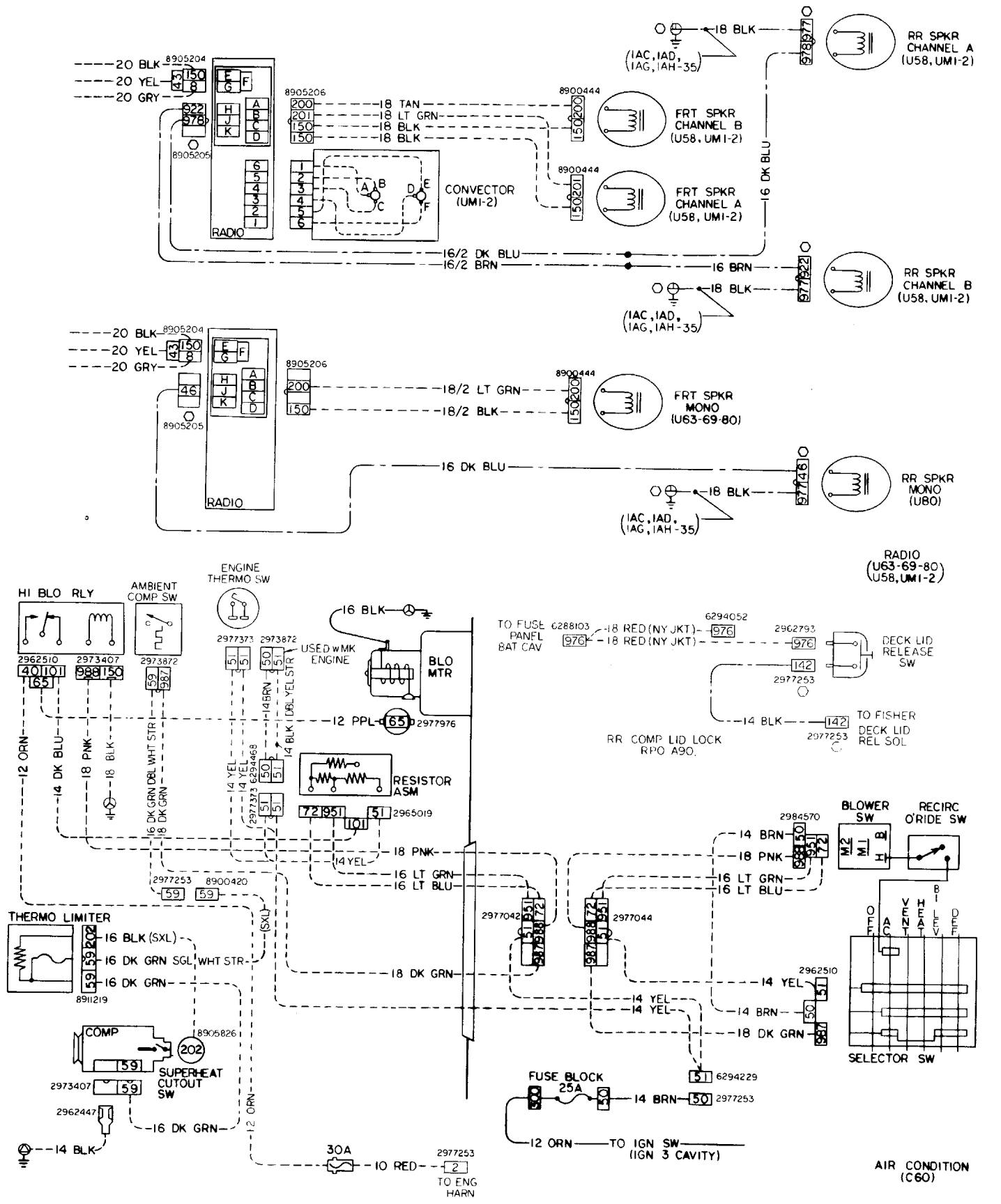

Left Side—Cab, Engine and Chassis Wiring—C-80; D-80—A-3415

